



STOJANY NA DVEŘE
STOJANY NA VZORKY SKEL



STOJANY NA DVEŘE



STOJANY NA DVEŘE



NA JEDNOKŘÍDLÉ DVEŘE



Společnost MAR-TOM by Vám ráda představila naši novou řadu stojanů. Nabízíme moderní a atraktivní řešení pro co nejlepší prezentaci našich produktů zákazníkům.

Máme k dispozici různé typy stojanů, aby bylo možné prezentovat širokou škálu produktů. Jejich konstrukce také umožňuje propojení několika stojanů, takže lze vytvořit zajímavé uspořádání.

- stojany na jedny jednokřídlé dveře
- stojany na dvojce jednokřídlé dveře
- stojany na dvoukřídlé dveře
- stojany na dveře s bočním světlíkem
- stojany na vzorky skel



Podsvícené logo společnosti



Elegantní skleněné zpracování

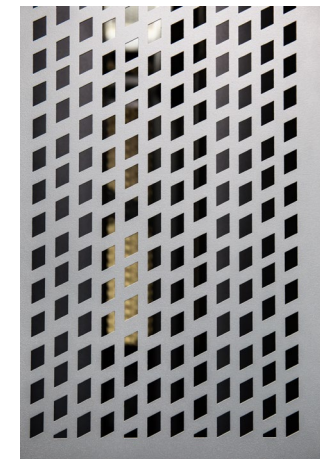

Perforace stojanu





STOJAN NA DVOJE JEDNOKŘÍDLÉ DVEŘE

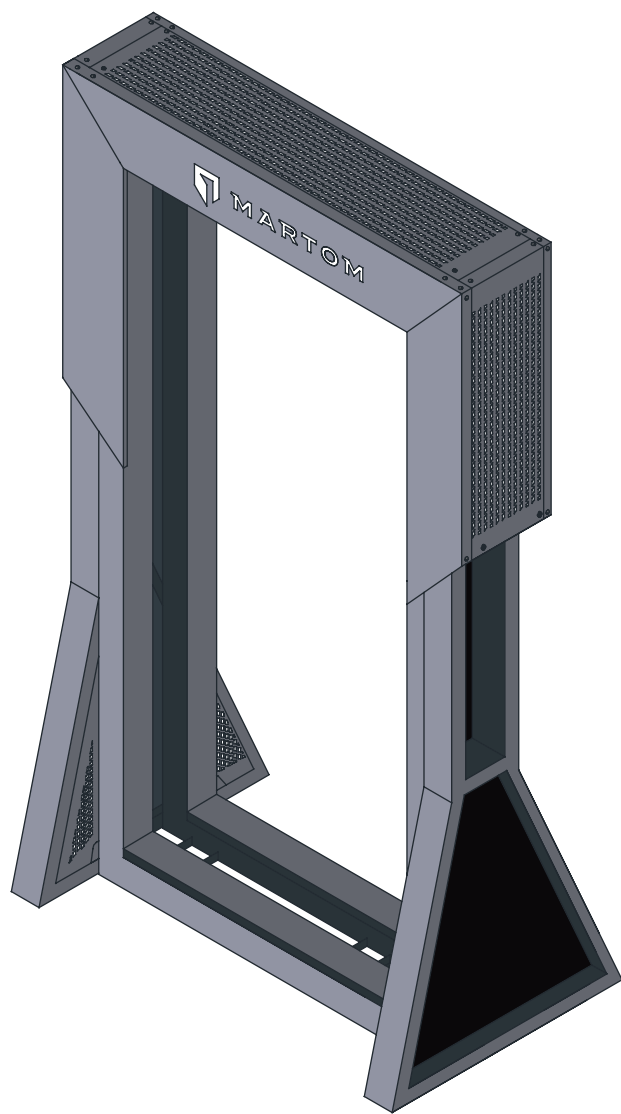

Výška stojanu - 2350 mm

Volně stojící dvojitý stojan určený pro dva kusy dveří.

Dvojitý stojan je k dispozici pouze s širokými nohama.

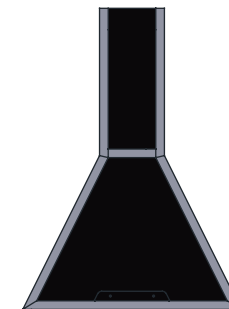

KONFIGURACE 1

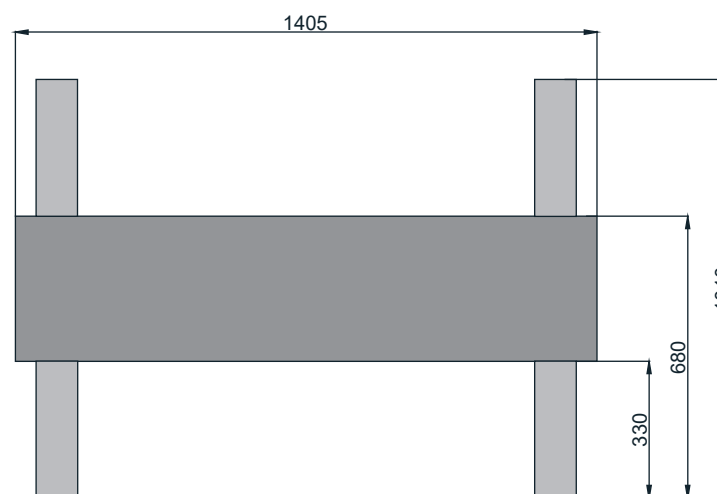

STOJAN NA DVOJE DVEŘE S BOČNÍMI SVĚTLÍKY

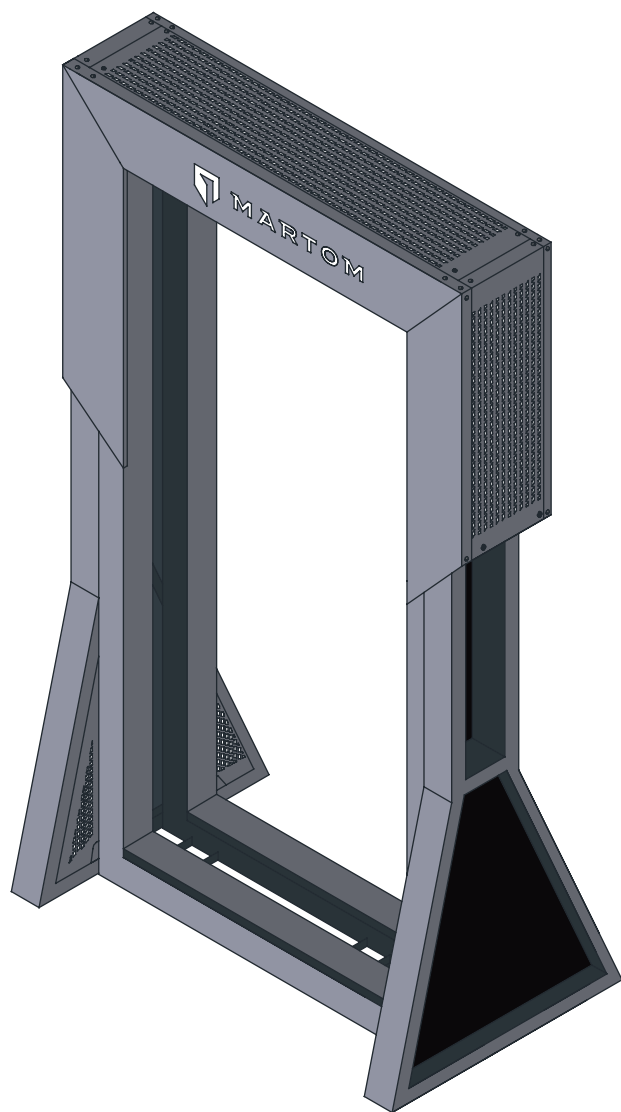

Výška stojanu - 2350 mm

Volně stojící dvojitý stojan na dva kusy dveří s bočními světly.

Dvojitý stojan je k dispozici pouze s širokými nohami.



KONFIGURACE 50

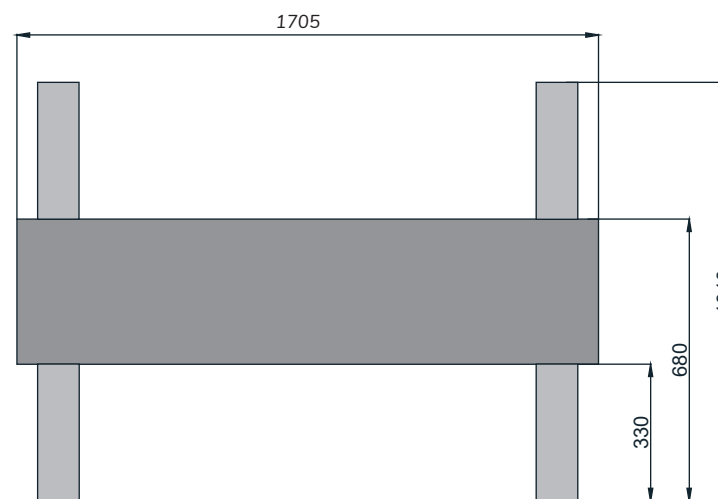

STOJAN NA JEDNY JEDNOKŘÍDLÉ DVEŘE

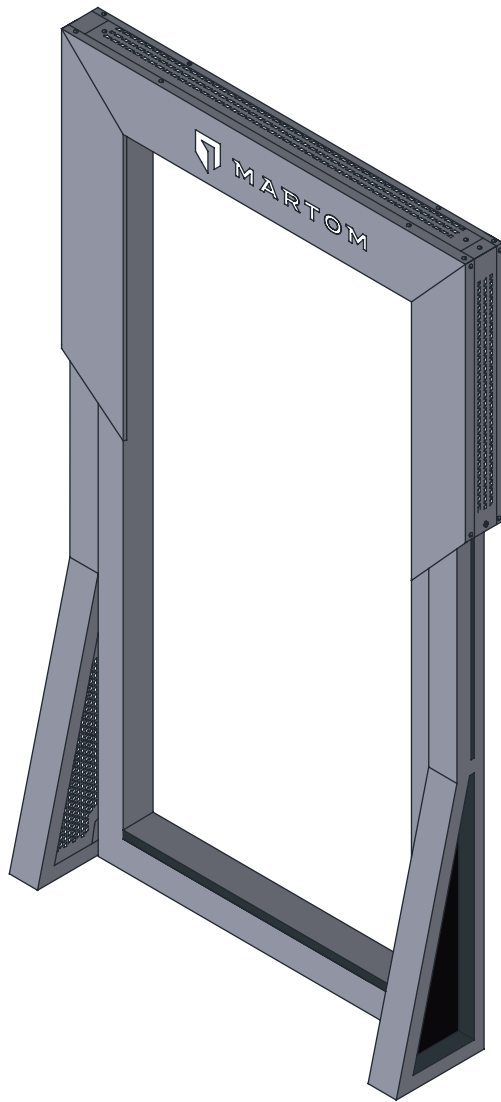

Výška stojanu - 2350 mm

Jednoduchý nástěnný stojan pro jedny dveře.

Jednoduchý stojan je k dispozici s trojúhelníkovými nebo rovnými nohami. Je také možné zvolit stojan s trojúhelníkovou nohou na jedné straně.

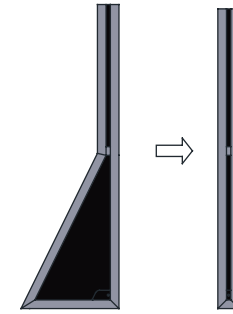

KONFIGURACE 2

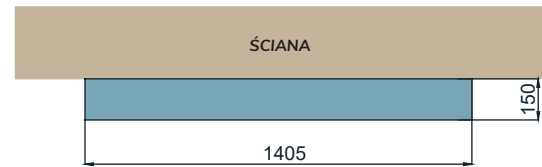

KONFIGURACE 3

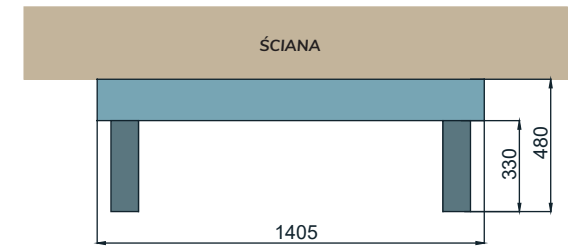

KONFIGURACE 4

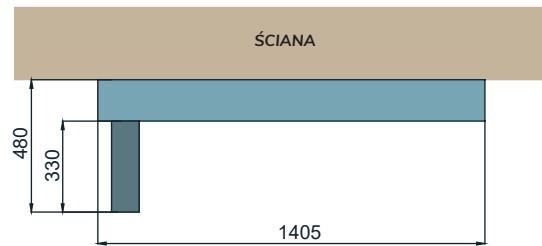

KONFIGURACE 5

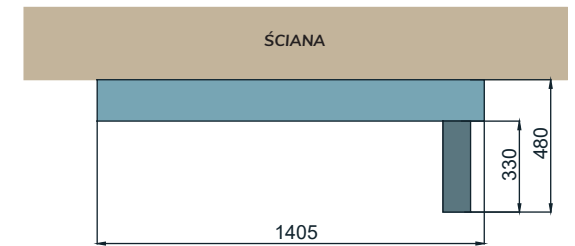

STOJAN NA JEDNY DVOUKŘÍDLÉ DVEŘE / S BOČNÍM SVĚTLÍKEM

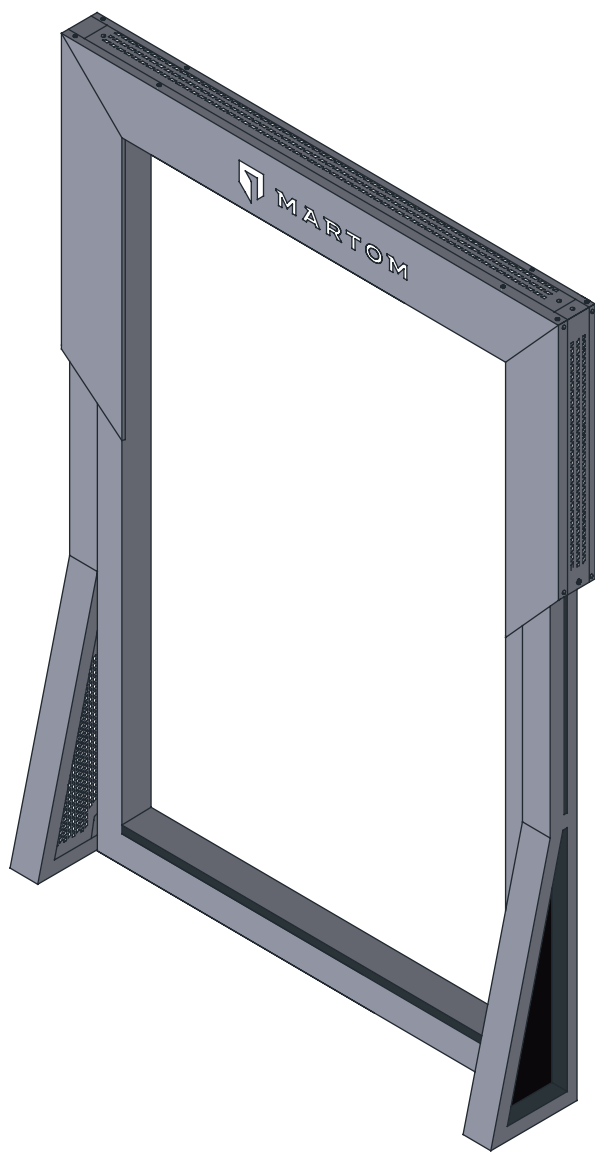

Výška stojanu - 2350 mm

Jednoduchý nástěnný stojan pro jednu dvoukřídlové dveře nebo dveře s bočním světlem.

Jednoduchý stojan je k dispozici s trojúhelníkovými nebo rovnými nohami. Je také možné zvolit stojan s trojúhelníkovou nohou na jedné straně.

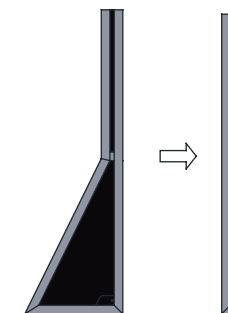

KONFIGURACE 6

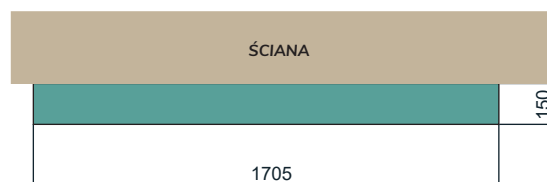

KONFIGURACE 7

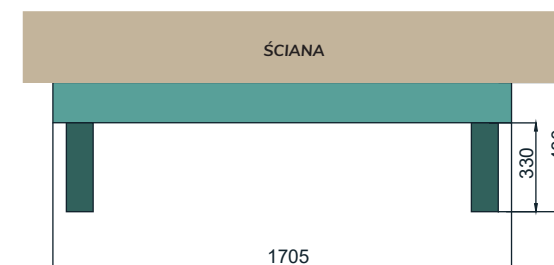

KONFIGURACE 8

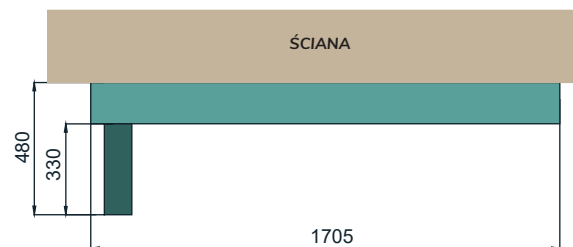

KONFIGURACE 9

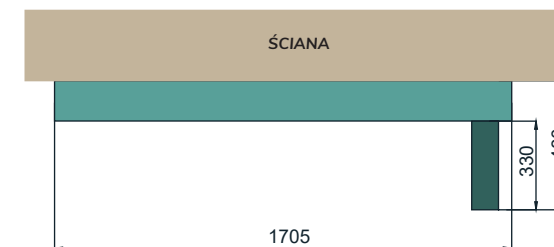

SPOJENÉ STOJANY

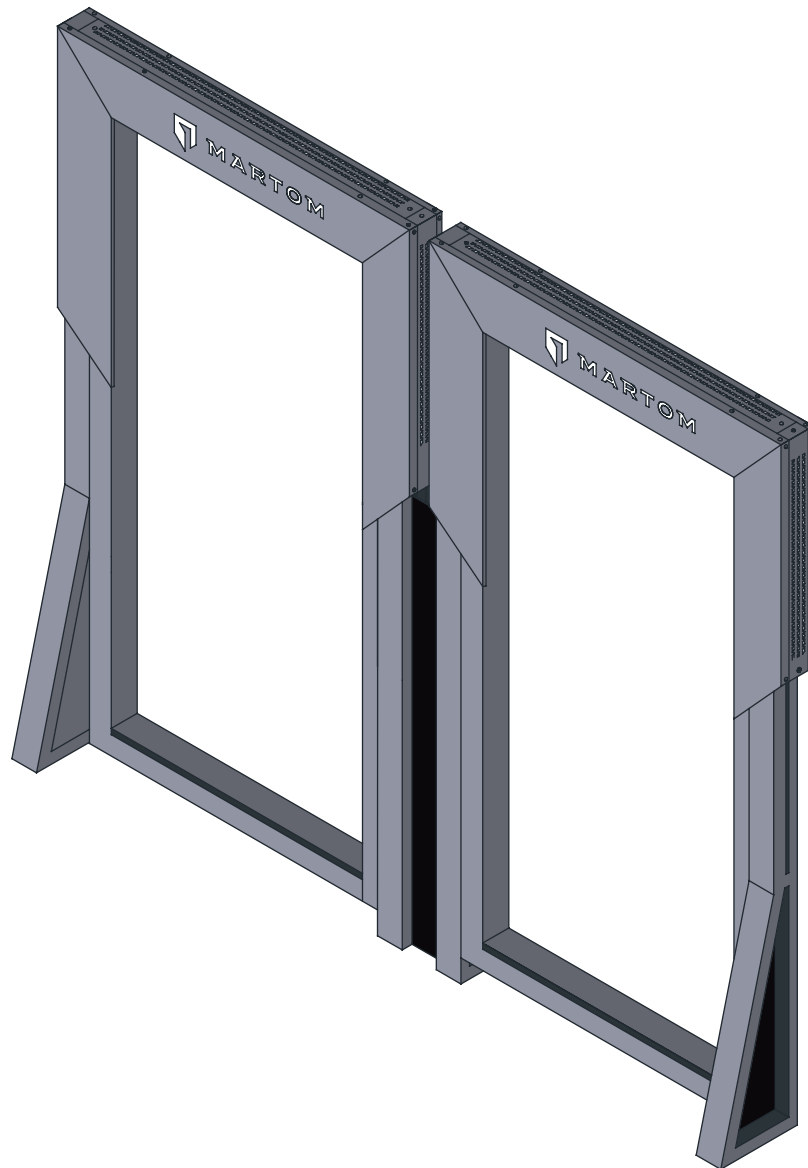

DVA JEDNOTLIVÉ STOJANY

KONFIGURACE 10

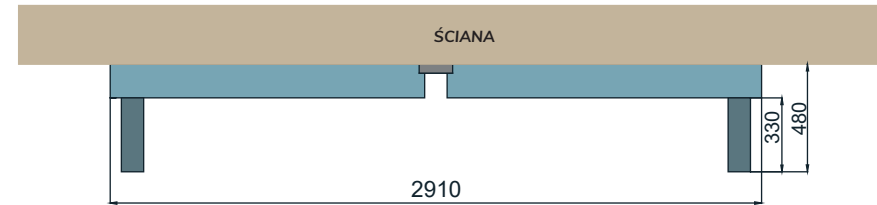

KONFIGURACE 11

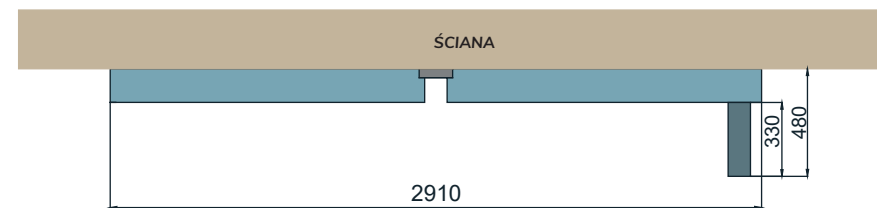

KONFIGURACE 12

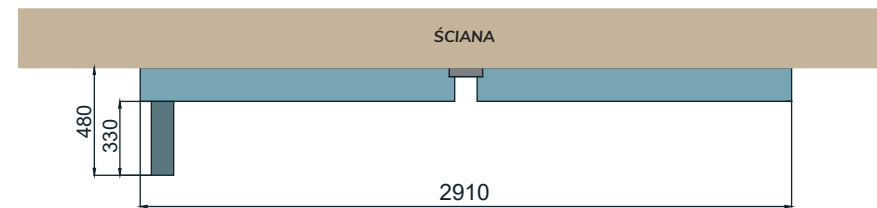

KONFIGURACE 13

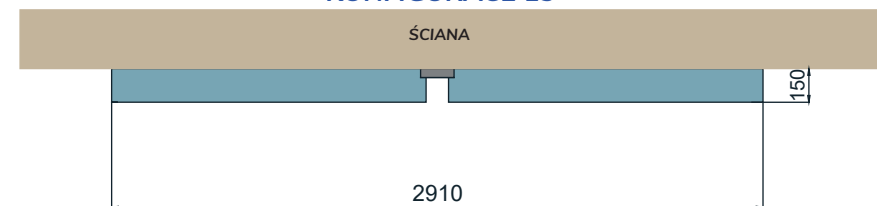

TŘI JEDNOTLIVÉ STOJANY

KONFIGURACE 14

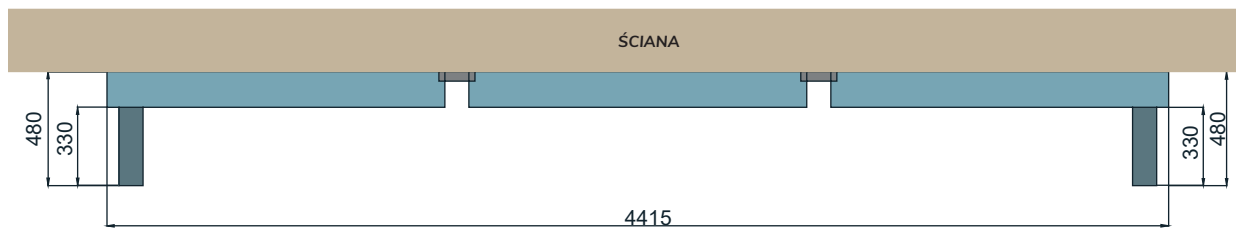

KONFIGURACE 15

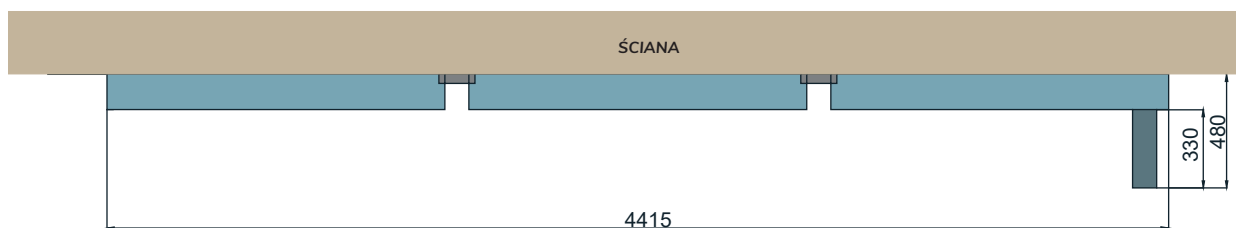

KONFIGURACE 16

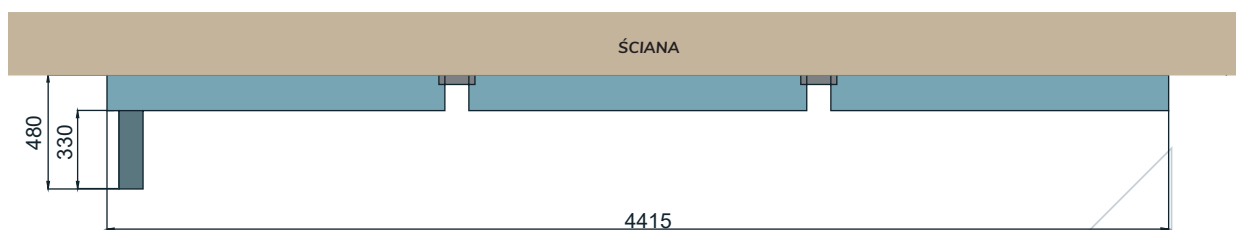

KONFIGURACE 17

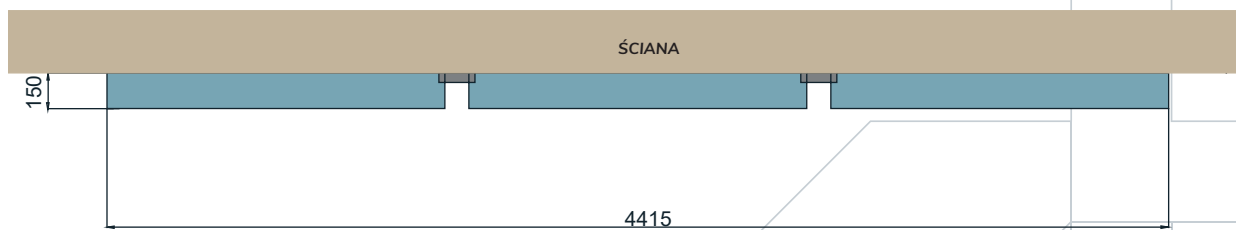

JEDNODUCHÝ STOJAN + STOJAN NA DVOUKŘÍDLÉ DVEŘE/ S BOČNÍM SVĚTLÍKEM



KONFIGURACE 18

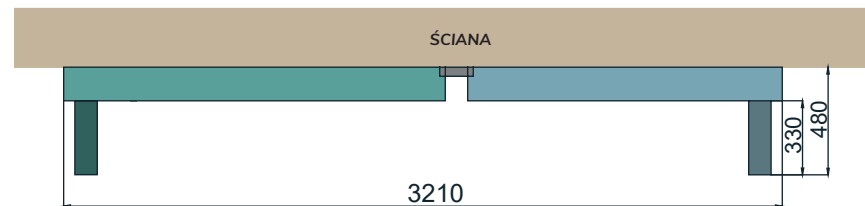

KONFIGURACE 19

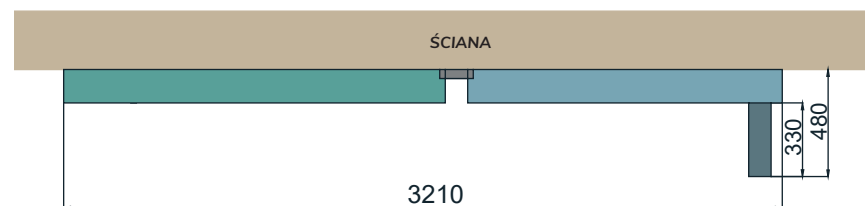

KONFIGURACE 20

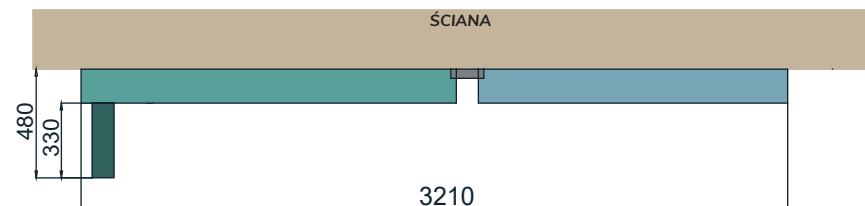

KONFIGURACE 21

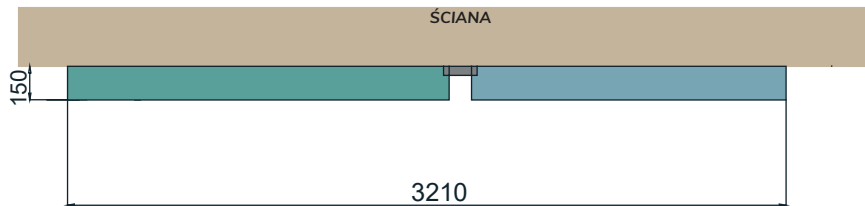

DVA JEDNODUCHÉ STOJANY + STOJAN NA DVOUKŘÍDLÉ DVEŘE/ S BOČNÍM SVĚTLÍKEM

KONFIGURACE 22

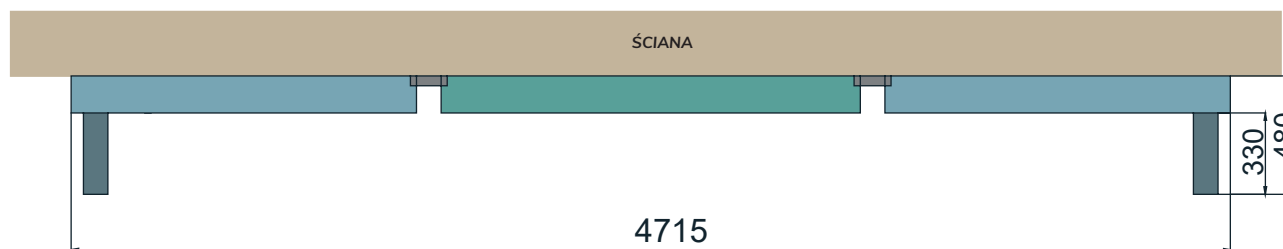

KONFIGURACE 23

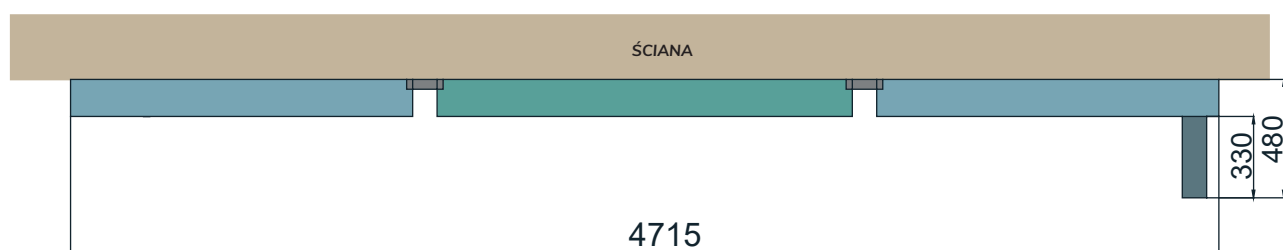

KONFIGURACE 24

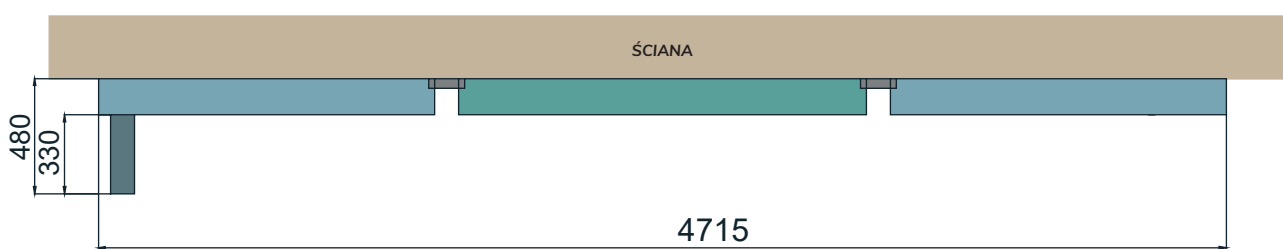

KONFIGURACE 25

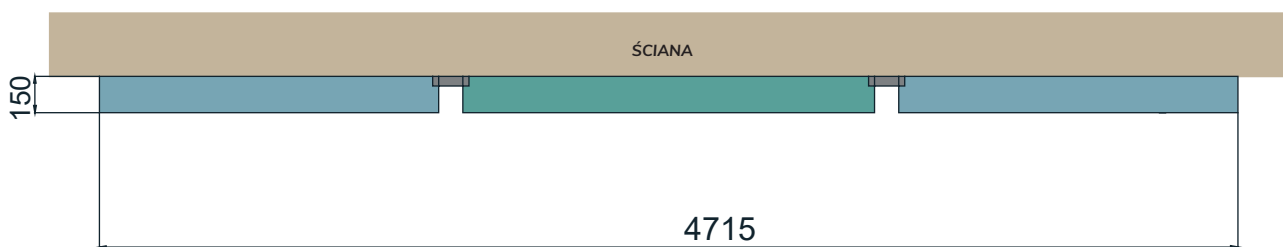

DVA JEDNOTLIVÉ STOJANY

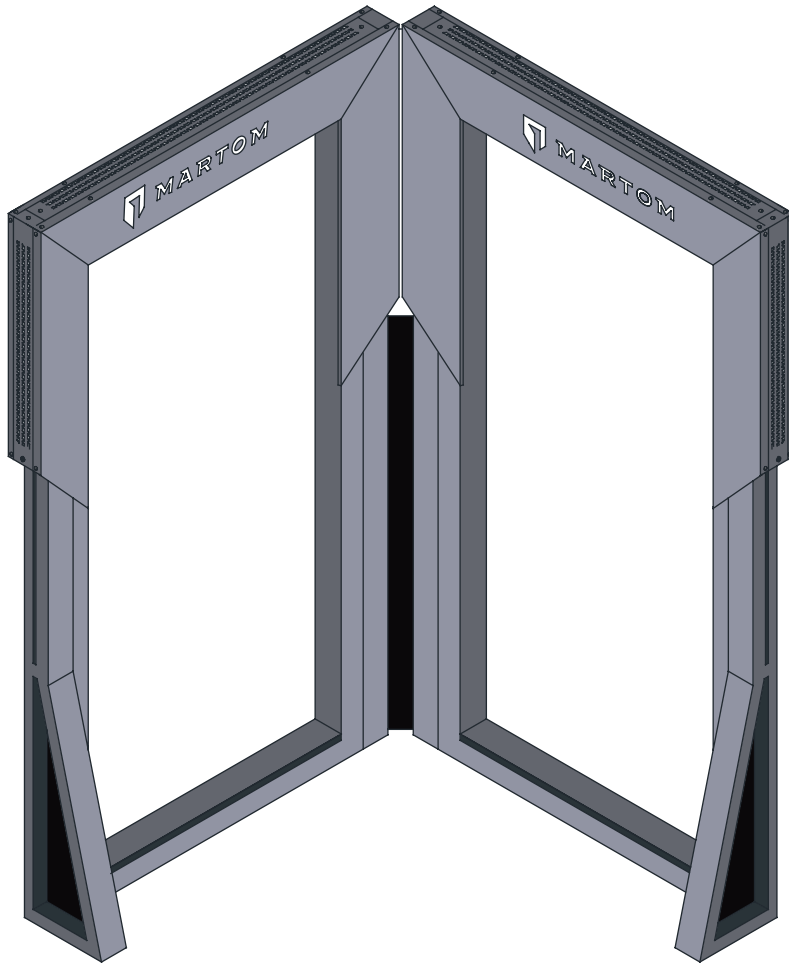

KONFIGURACE 26

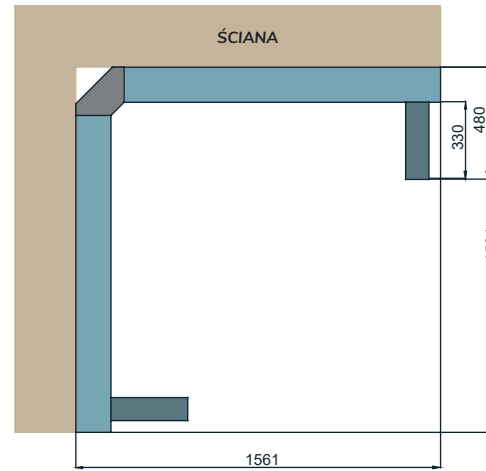

KONFIGURACE 27

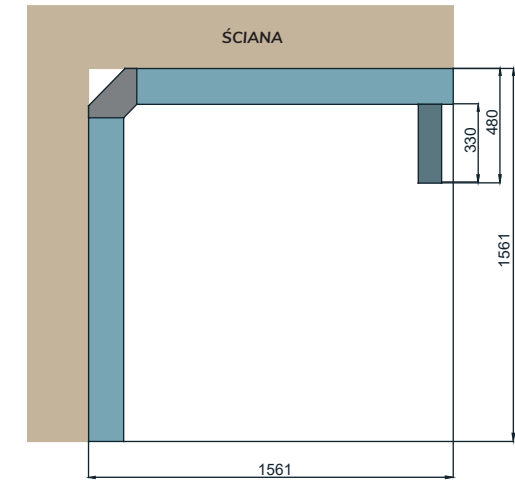

KONFIGURACE 28

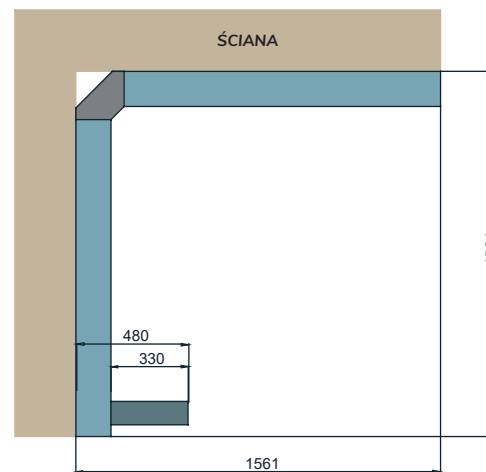

KONFIGURACE 29

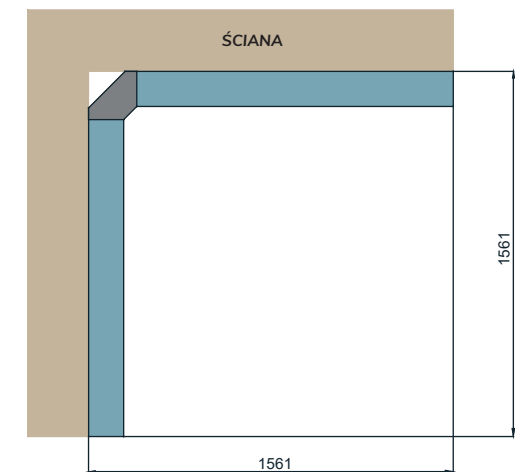

JEDNODUCHÝ STOJAN + STOJAN NA DVOUKŘÍDLÉ DVEŘE/ S BOČNÍM SVĚTLÍKEM

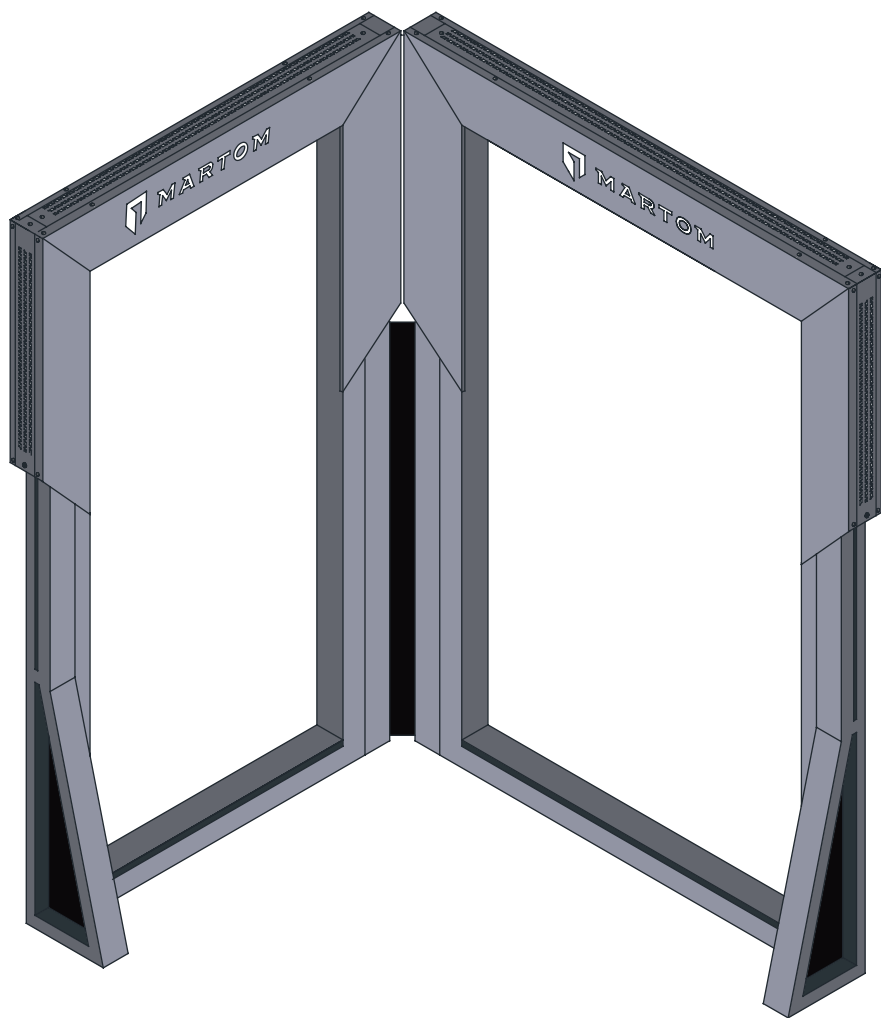

KONFIGURACE 30

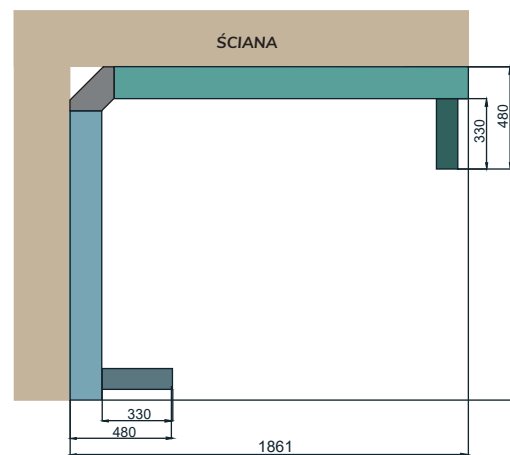

KONFIGURACE 31

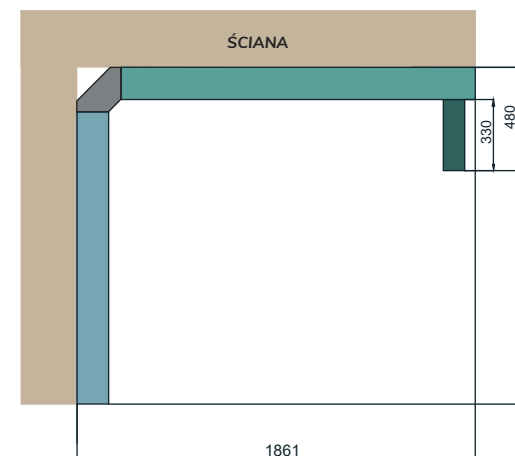

KONFIGURACE 32

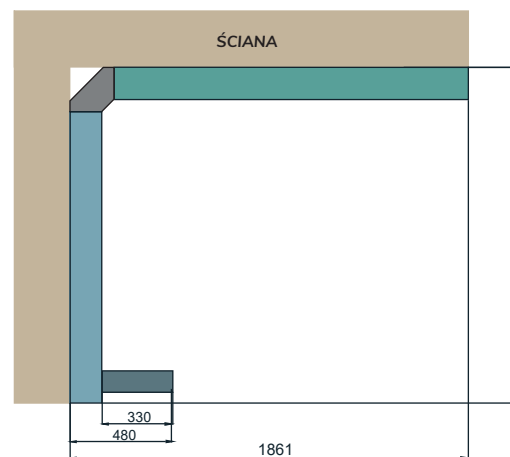

KONFIGURACE 33

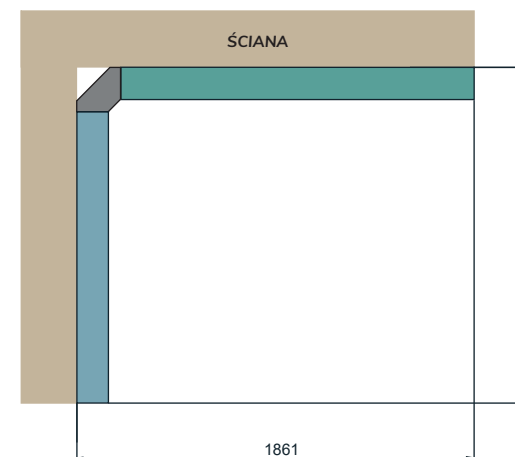

SPOJENÉ STOJANY

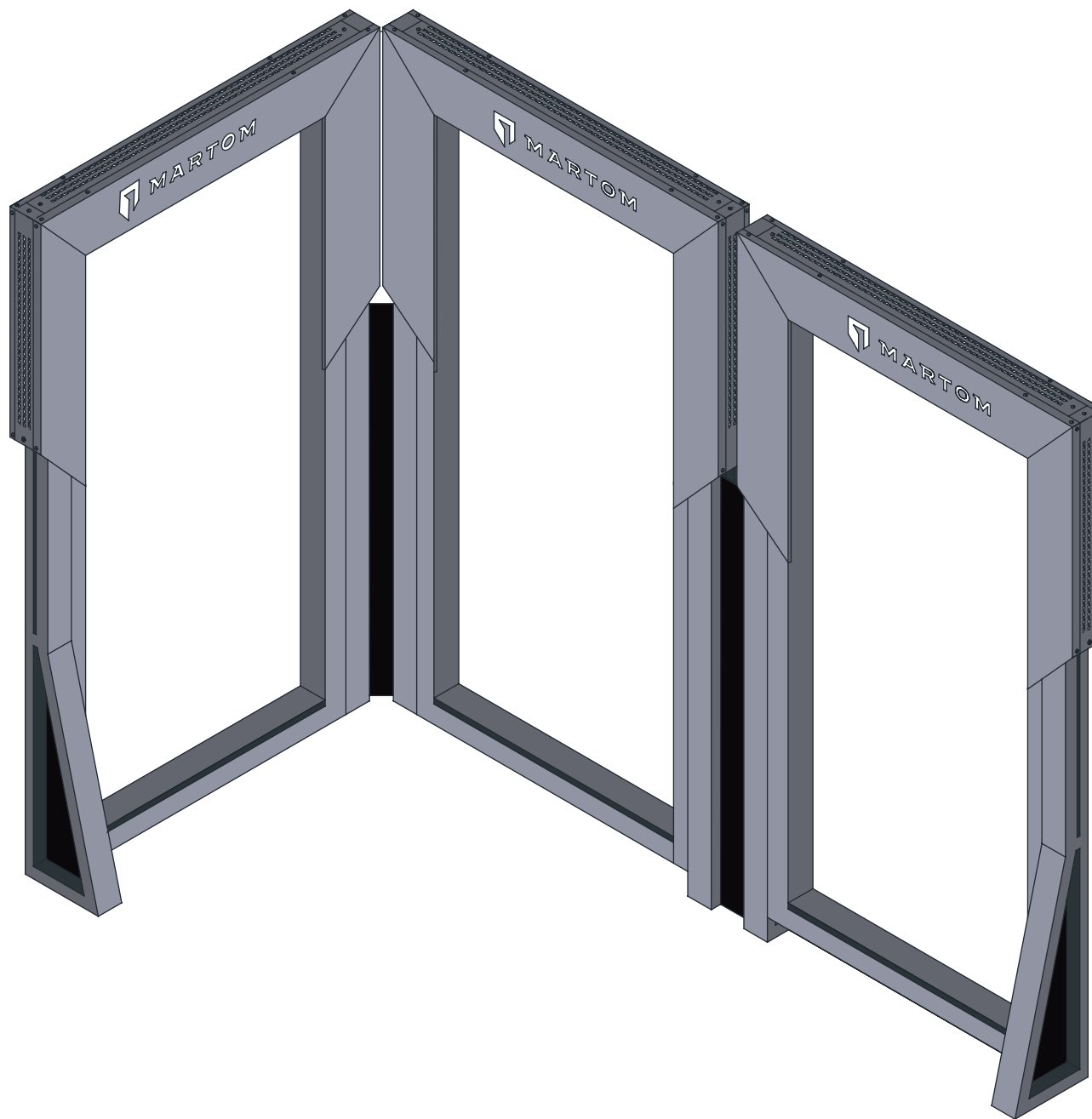

TŘI JEDNOTLIVÉ STOJANY

KONFIGURACE 34

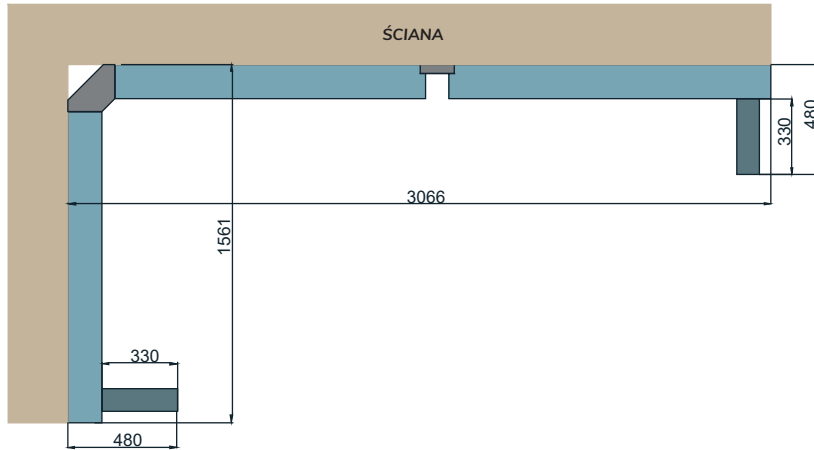

KONFIGURACE 35

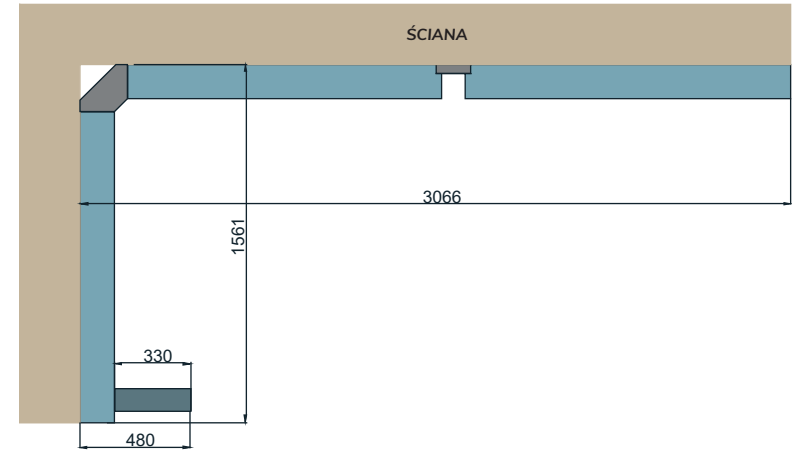

KONFIGURACE 36

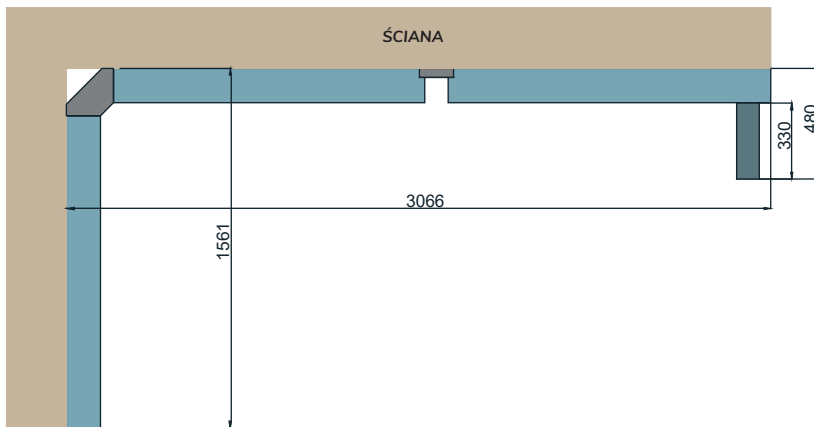

KONFIGURACE 37

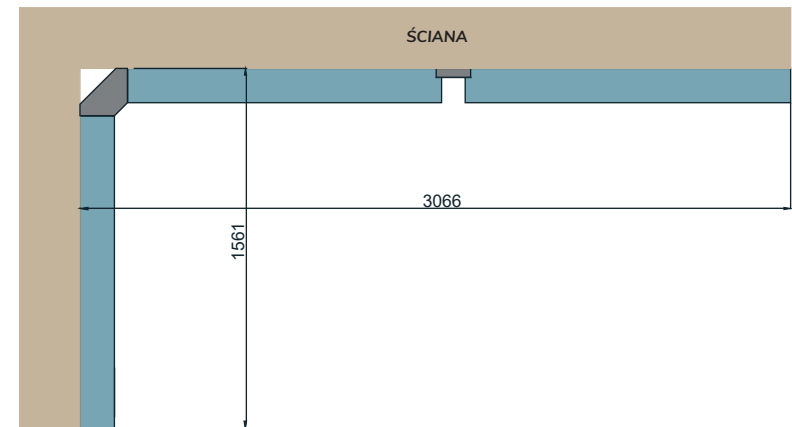

DVA JEDNODUCHÉ STOJANY + STOJAN NA DVOUKŘÍDLÉ DVEŘE/ S BOČNÍM SVĚTLÍKEM

KONFIGURACE 38

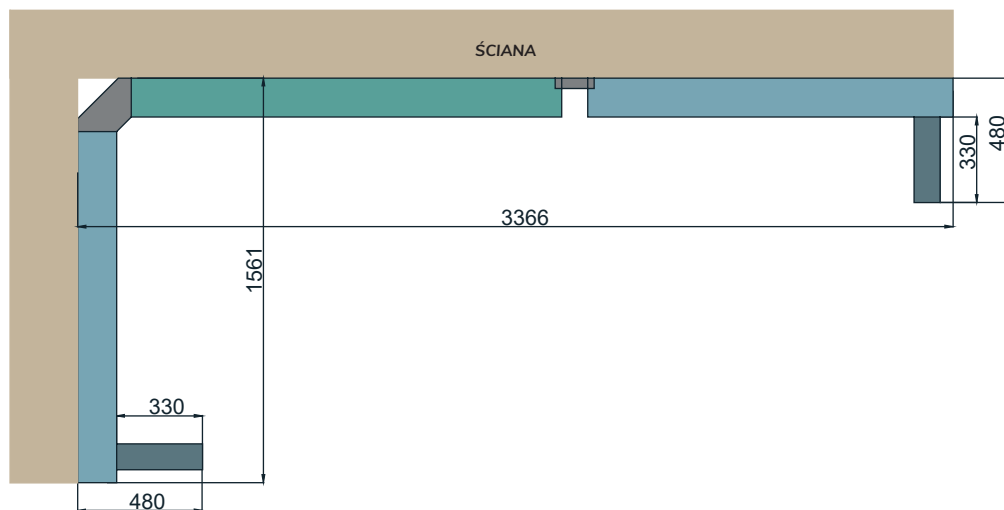

KONFIGURACE 39

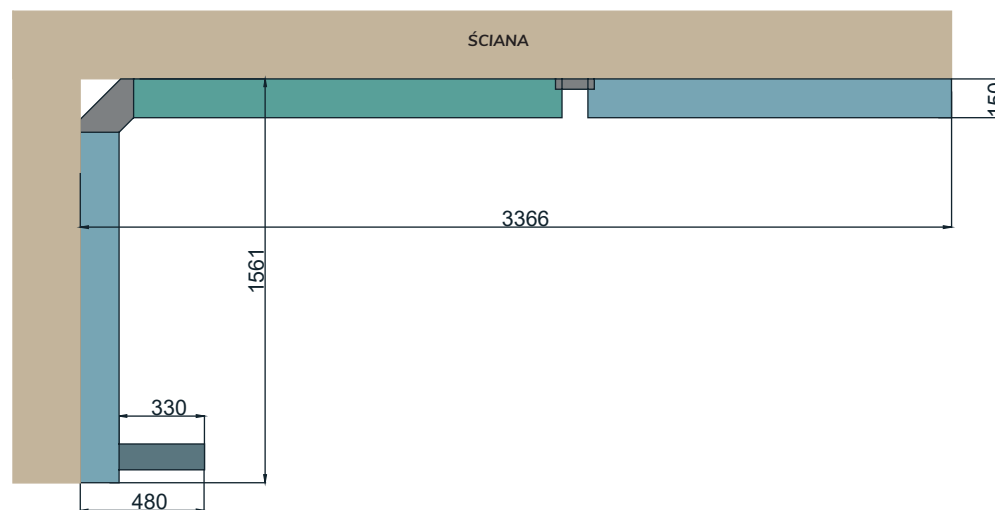

KONFIGURACE 40

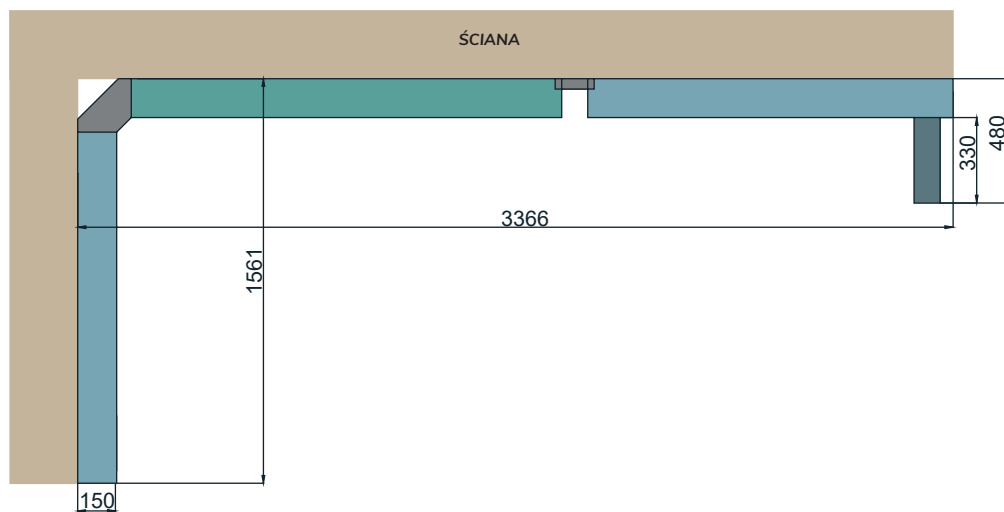

KONFIGURACE 41

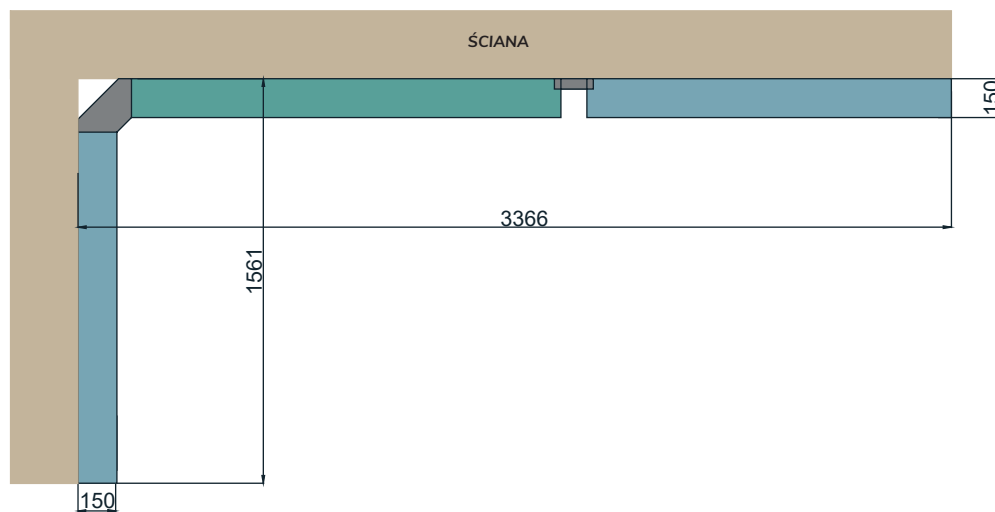

DVA JEDNODUCHÉ STOJANY + STOJAN NA DVOUKŘÍDLÉ DVEŘE/ S BOČNÍM SVĚTLÍKEM

KONFIGURACE 42

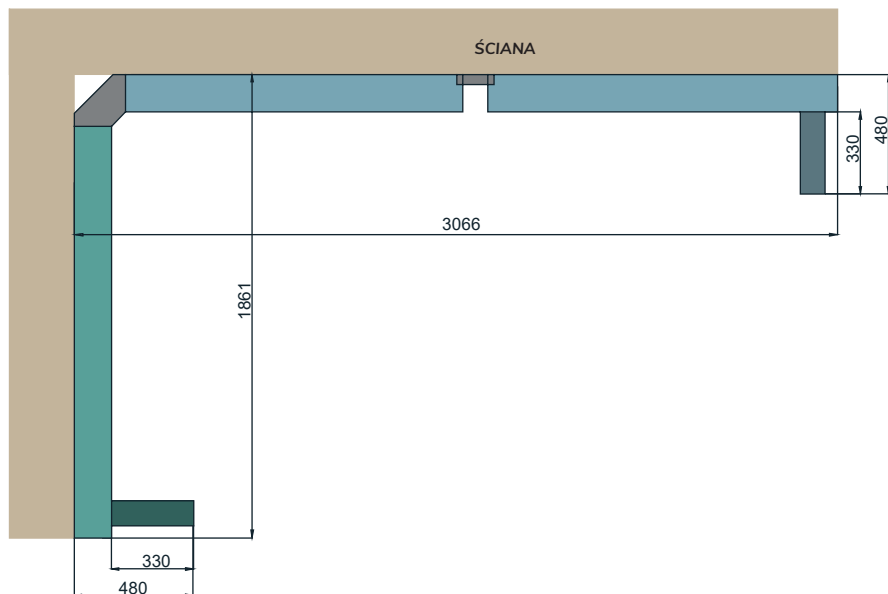

KONFIGURACE 43

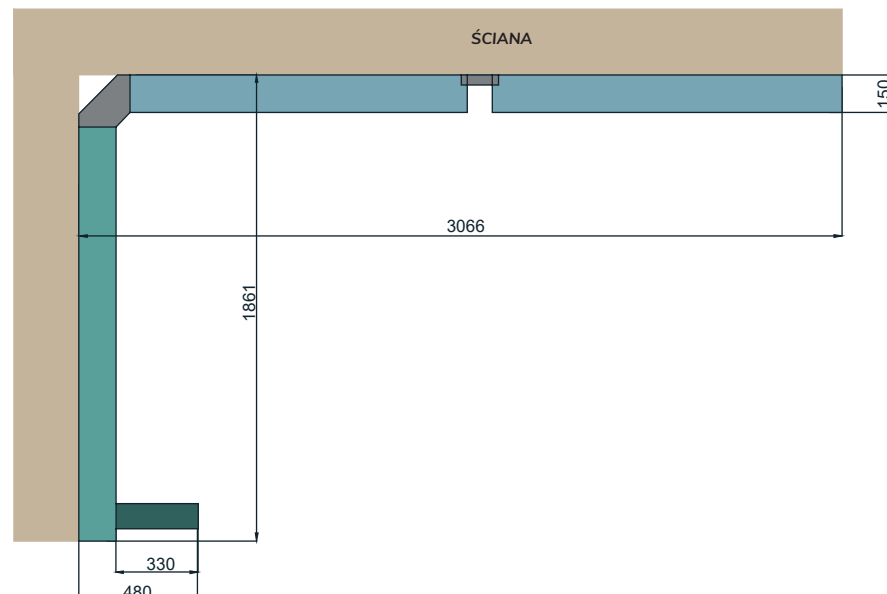

KONFIGURACE 44

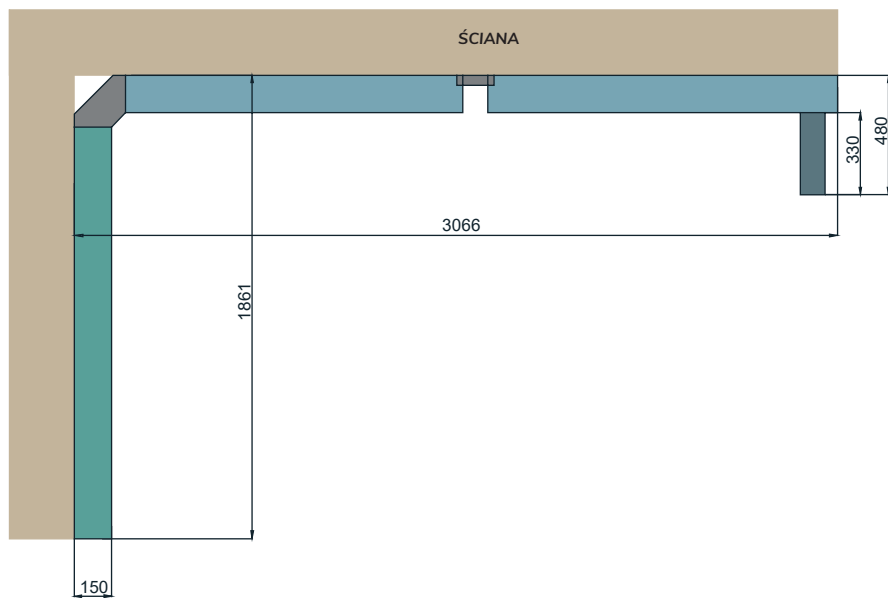

KONFIGURACE 45

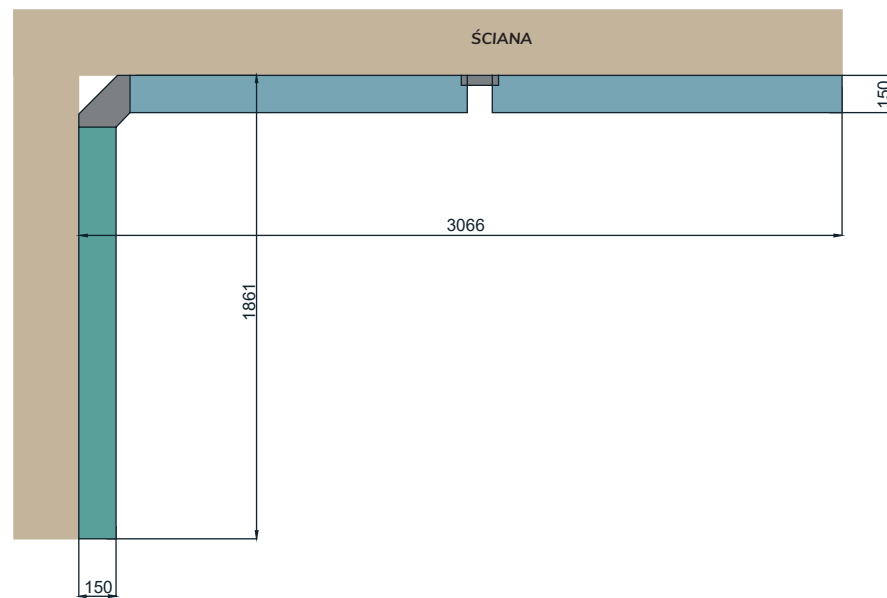

SPOJENÉ STOJANY

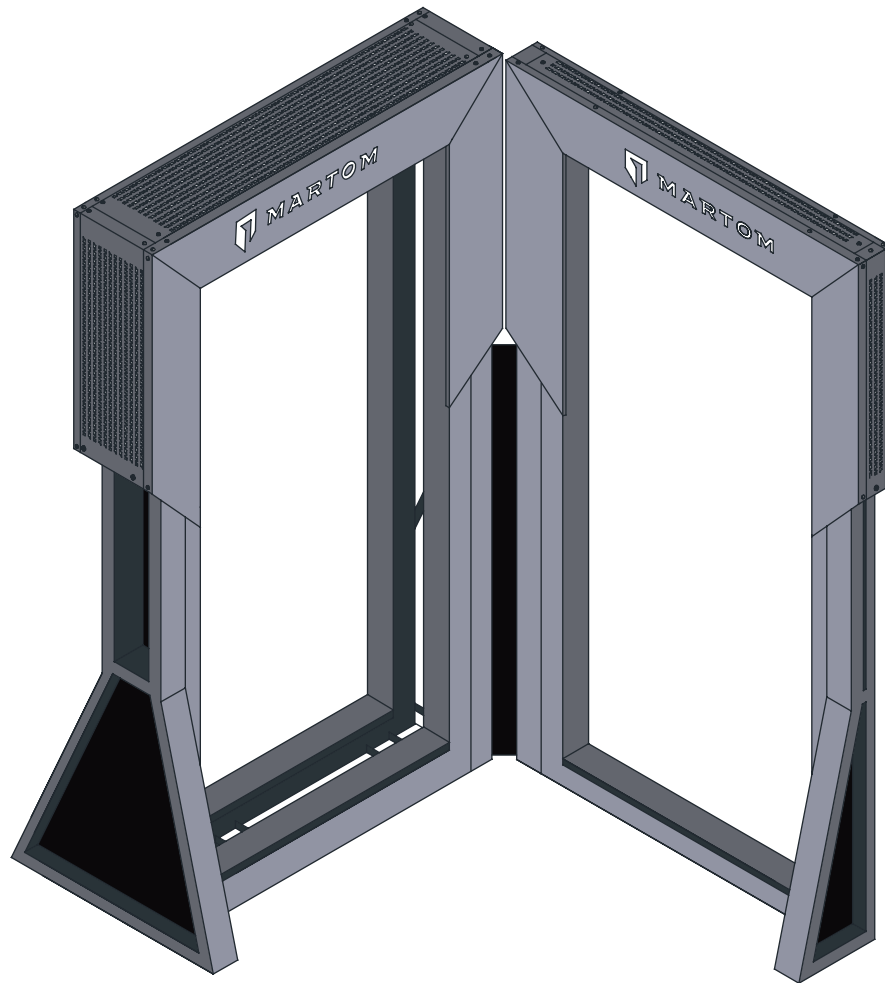

DVA JEDNOTLIVÉ STOJANY

KONFIGURACE 46

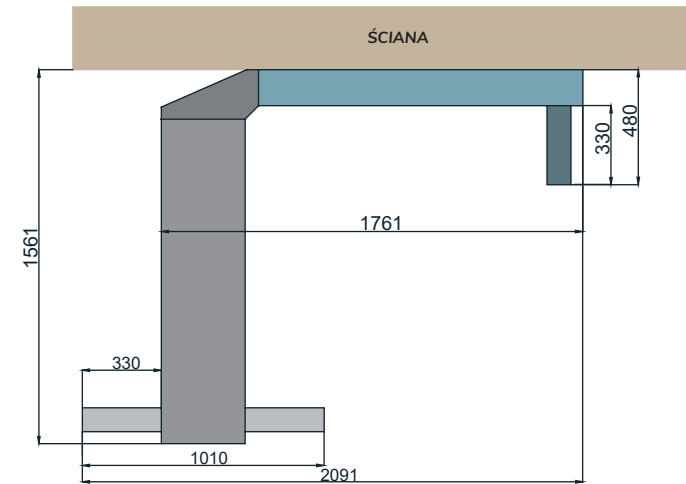

KONFIGURACE 47

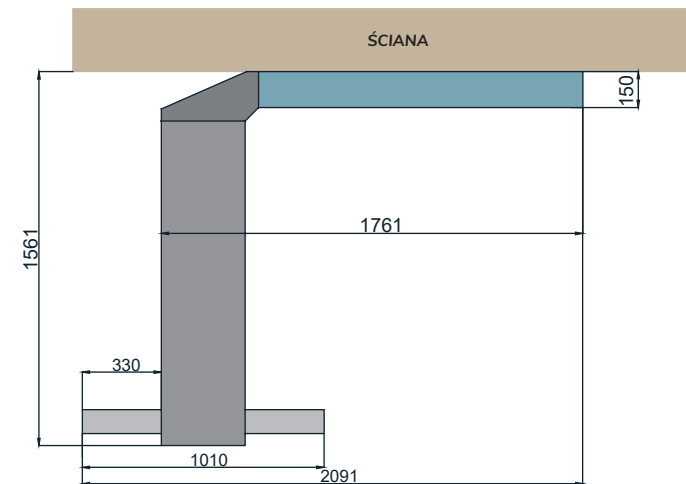

SPOJENÉ STOJANY

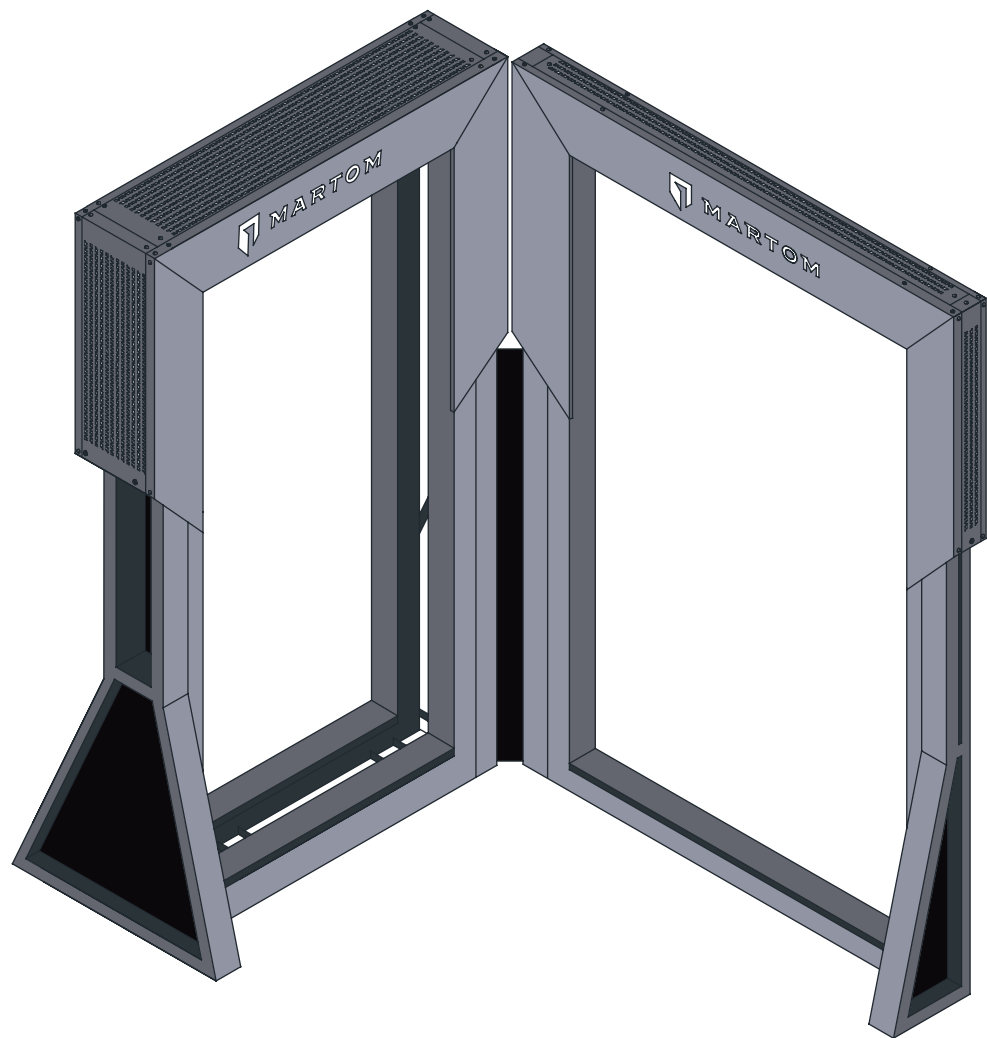

DVA JEDNOTLIVÉ STOJANY

KONFIGURACE 48

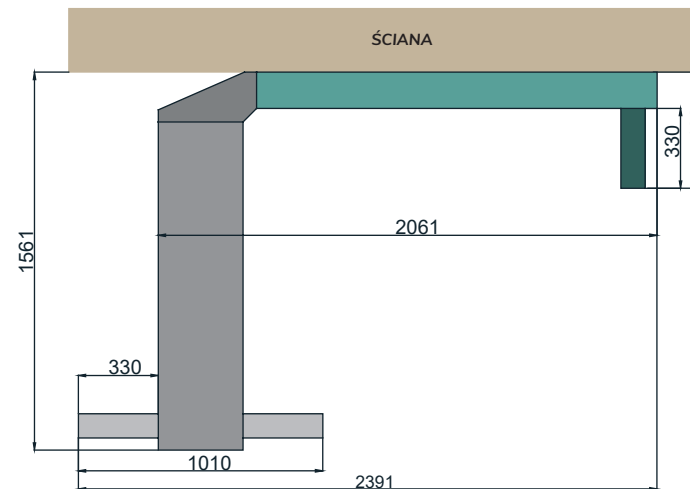

KONFIGURACE 49

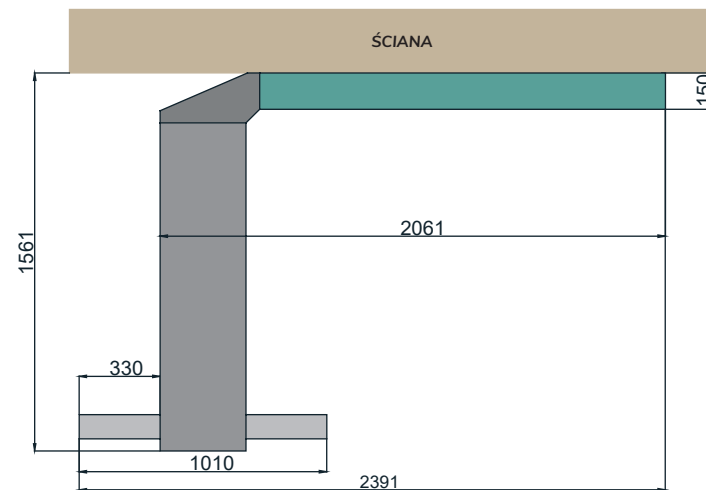

STOJANY NA VZORKY SKEL

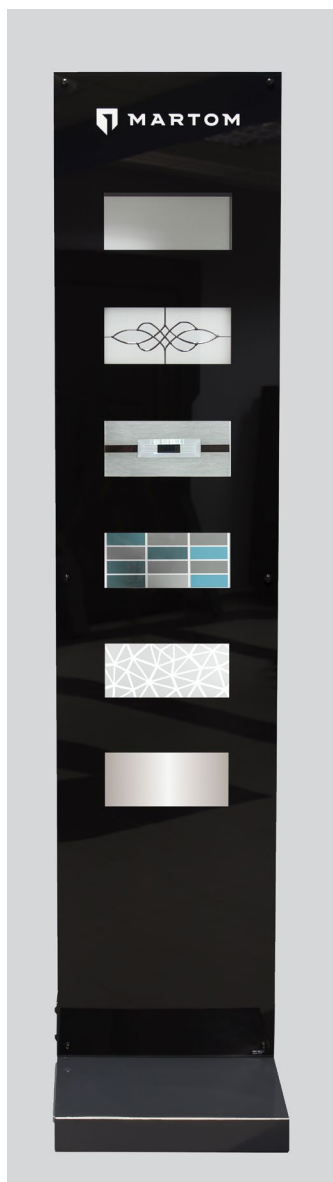

STOJAN NA VZORKY SKEL 1

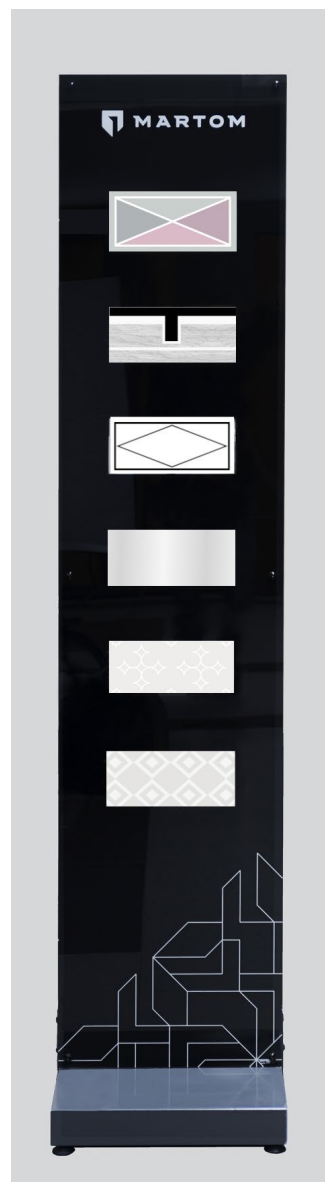

STOJAN NA VZORKY SKEL 2

Společnost Mar-Tom nabízí široký sortiment prosklení. S našimi novými stojany je možné prezentovat zákazníkům vybrané návrhy prosklení. Uvedené stojany mají malou, robustní konstrukci. Přední strana je vyrobená z tvrzeného skla, díky čemuž je i vizuálně velmi atraktivní. Každý stojan je určen k prezentaci šesti vybraných prosklení. Konstrukce stojanů také umožňuje jejich pozdější výměnu.

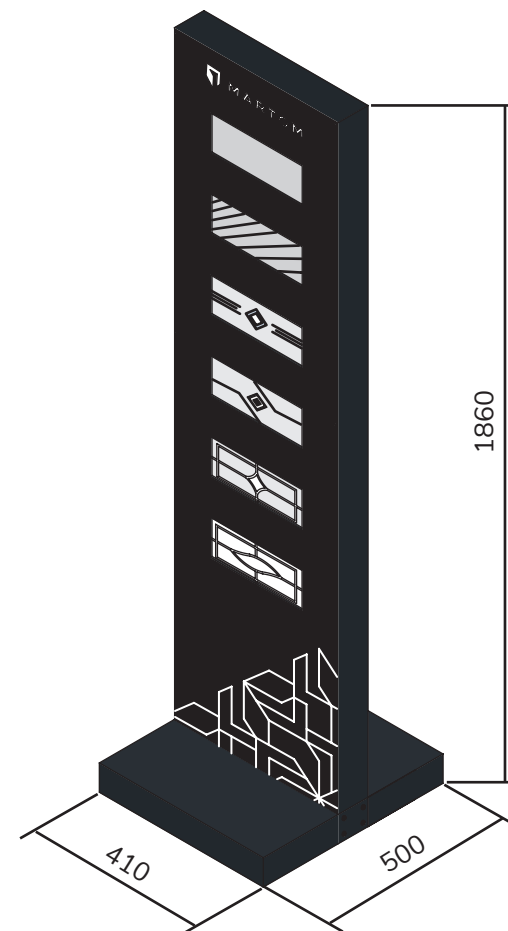
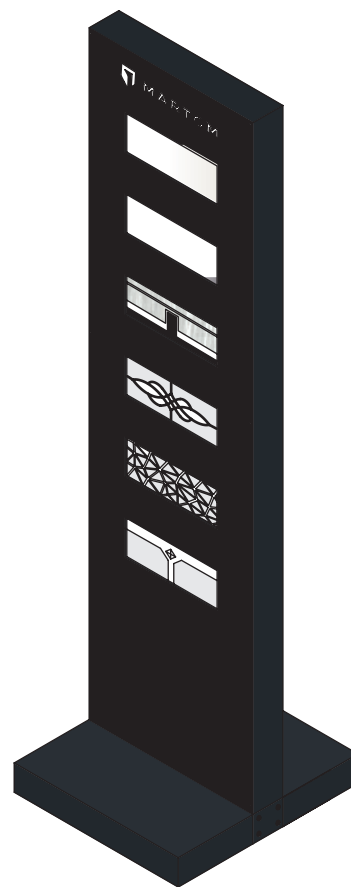

VZORNÍK SKEL

V případě nedostatku místa na stojan na vzorky skel je k dispozici přenosný vzorník skel o malých rozměrech 9 m x 16,5 cm x 34 cm obsahující vybrané vzorky skel.

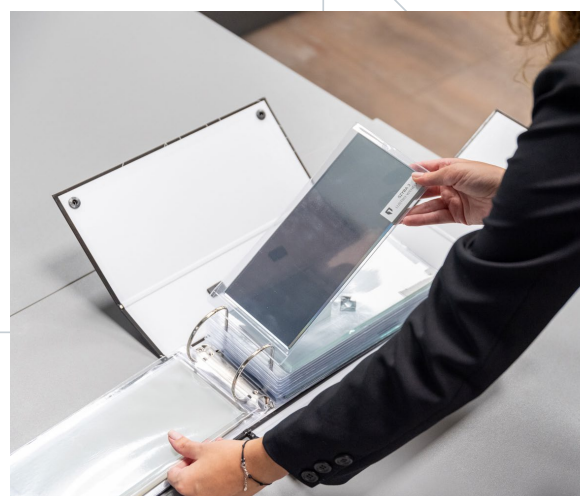
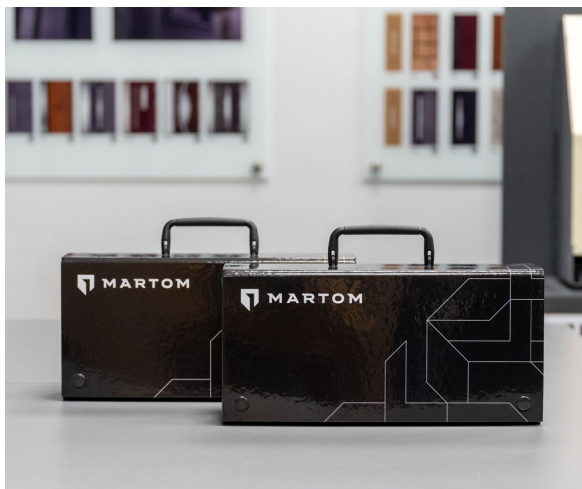

DOSTUPNÁ PROVEDENÍ ZASKLENÍ - PRO STOJAN NA VZORKY SKEL A VZORNÍK SKEL



SKLO 1
REFLEX HNĚDÁ



SKLO 3
ZRCADLOVÉ SKLO

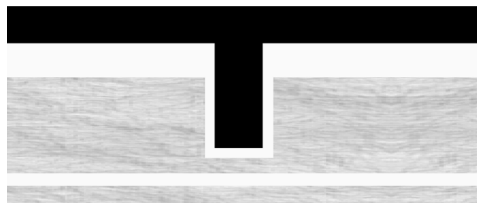

SKLO 7
TISK

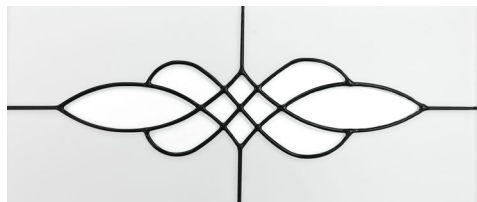

SKLO 9
TISK



SKLO 15
TISK (59F)

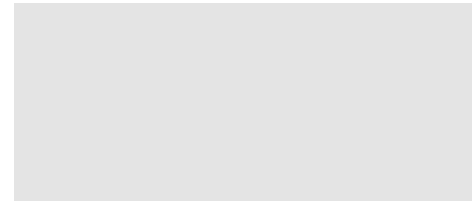

SKLO 2
MLÉČNÁ

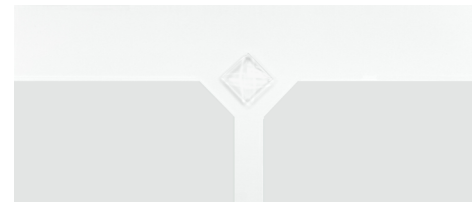

SKLO 6
PÍSKOVANÁ



SKLO 8
TISK

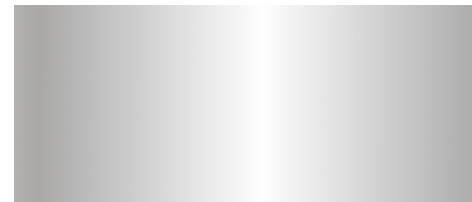

SKLO 14
REFLEX GRAFIT

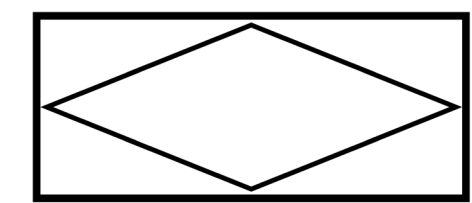

SKLO 16
TISK (57E)

DOSTUPNÁ PROVEDENÍ ZASKLENÍ - PRO STOJAN NA VZORKY SKEL A VZORNÍK SKEL



SKLO 17
TISK (59H)

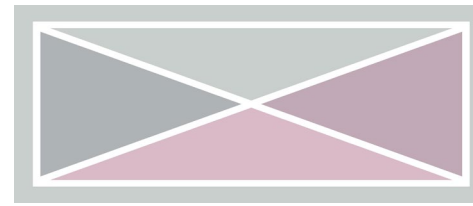

SKLO 18
TISK (59I)



SKLO 19
TISK (58E)



SKLO 20
TISK



SKLO 21
ČERNÁ



SKLO 22
TISK LISTY

VZORNÍK BAREV



ROŽEK - ZÁRUBEŇ + DVEŘNÍ KŘÍDLO

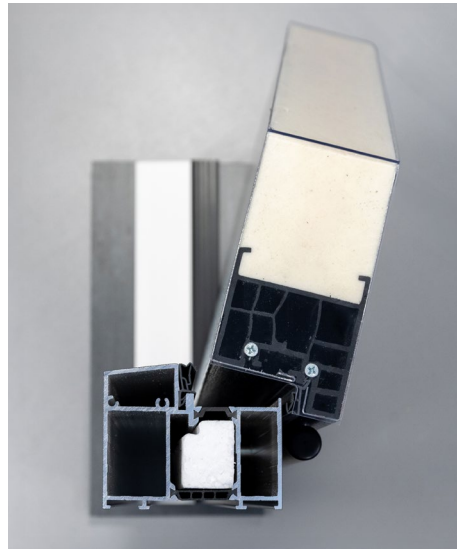

Rožky jsou umístěny na podstavci 40x20cm. Výška rožku se základnou = 57 cm

Dostupné rožky pro standardy:

- 55 Nordic, rám v křídle dřevo
- 72 Arctic s kovovou/dřevěnou zárubní, rám v křídle dřevo
- 72 Arctic s hliníkovou zárubní, rám v křídle ABS
- 90 Passive s kovovou/dřevěnou zárubní, rám v křídle ABS
- 90 Pasivní s hliníkovou zárubní, rám v křídle ABS

ŘEZY ZÁRUBNÍ

Dostupné vzorky zárubní:

- kovová/dřevěná zárubeň s hliníkovým prahem (rozměr 22x17cm)
- hliníková zárubeň s hliníkovým prahem (rozměr 22x17cm)
- asymetrická ocelová zárubeň (výška 30 cm)
- symetrická ocelová zárubeň (výška 30 cm)
- rohová ocelová zárubeň (výška 30 cm)

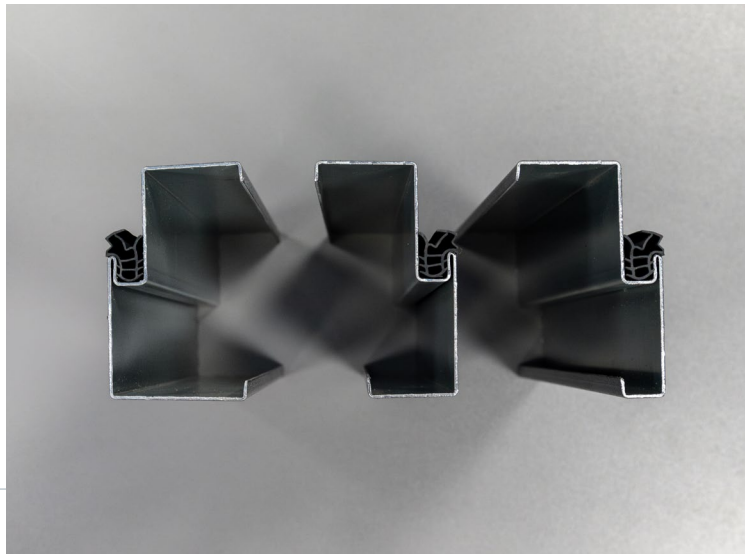

Asymetrická ocelová zárubeň 92mm



Asymetrická ocelová zárubeň 150mm

